

ATLAS

Krane / Cranes / Grues / Grúa

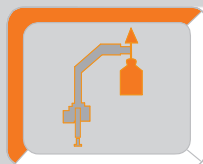

max : **2450 kg**

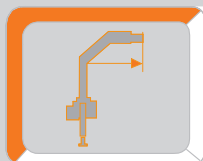

max : **10,96 m**

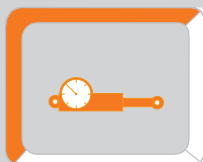

max : **300 bar**

AVAILABLE & COST EFFECTIVE

LASTKURVEN

Load Diagram-Courbes de charges-Curvas de cargas - Diagramma di portata

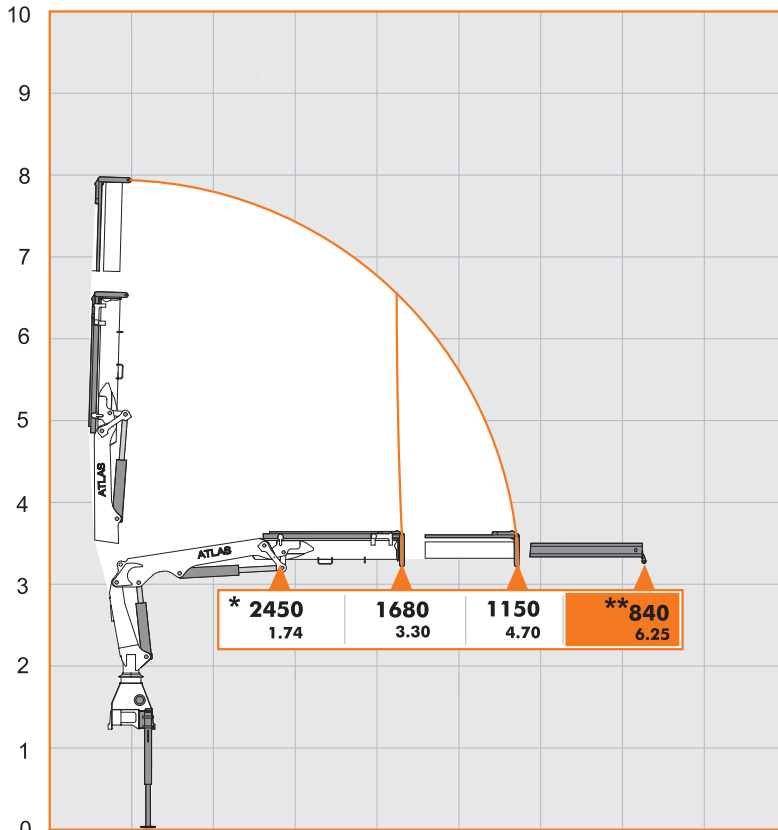

Hubarmstellung 10°/ boom position 10°/ Faites tonner la position à 10°/ Lance posición 10°

AK 57.3 A1

Kg Traglast/lifting capacity/En soulevant la capacité /Levantando capacidad in "Kg"
m Mass/measurement/des mesure/de medición in "m"

** - Optional { manuelle Verlängerung
manuell extension
l'extension mécanique
extensiones manuales

* { zusätzlicher Lasthakenpunkt am Knickarm
additional load hook point at jib
supplémentaires point crochet à flèche
carga adicional punto de gancho en la horca

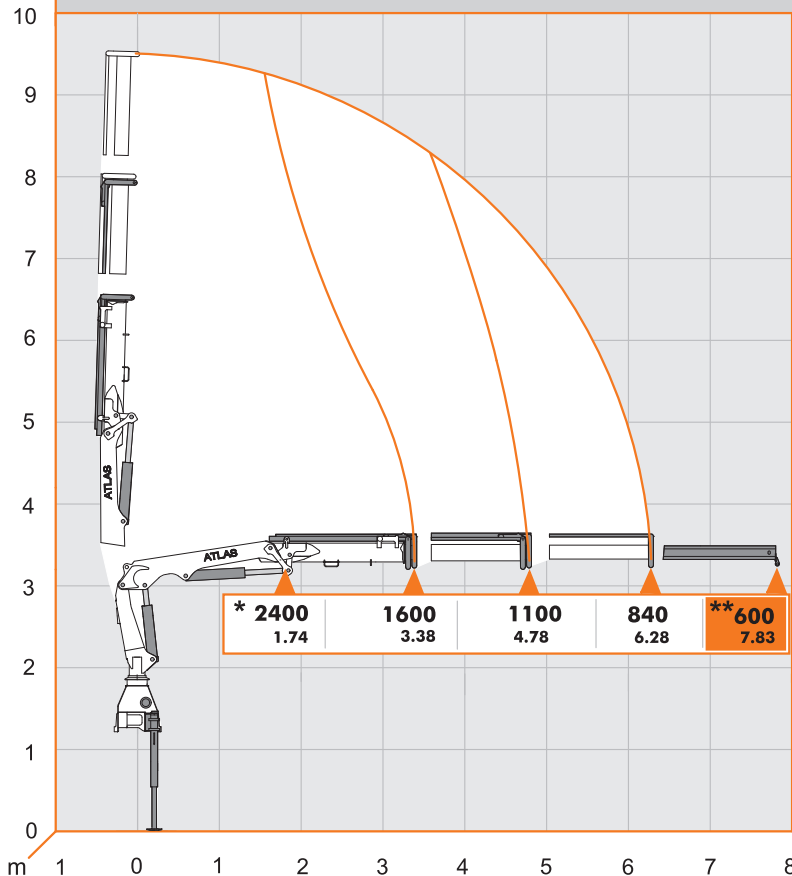

AK 57.3 A2

Kg Traglast/lifting capacity/En soulevant la capacité /Levantando capacidad in "Kg"
m Mass/measurement/des mesure/de medición in "m"

LASTKURVEN

Load Diagram-Courbes de charges-Curvas de cargas - Diagramma di portata

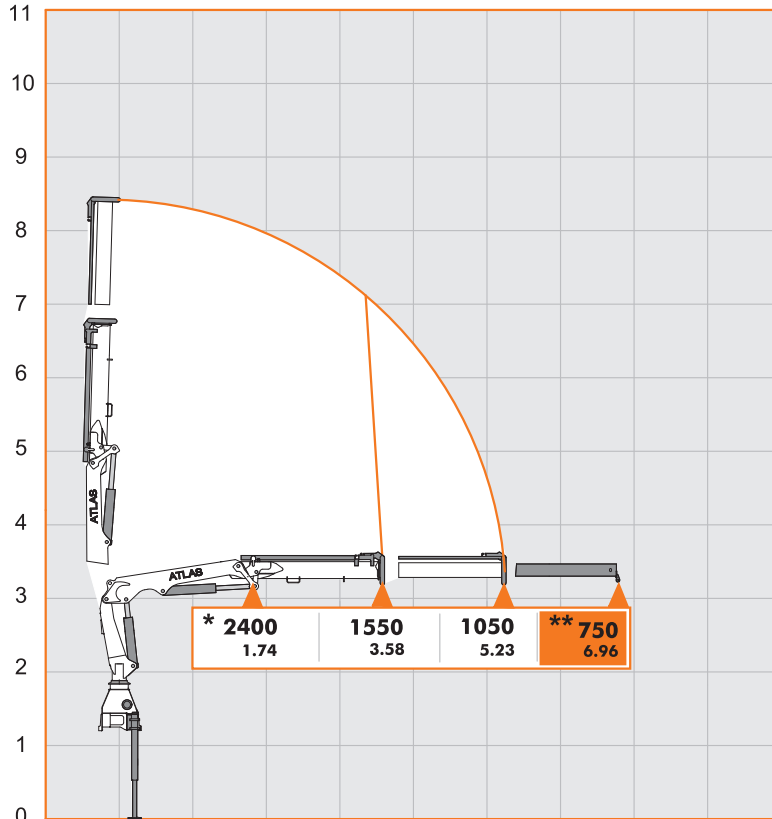

Hubarmstellung 10° / boom position 10° / Faites tonner la position à 10° / Lance posición 10°

AK 57.3 A1L

Kg Traglast/lifting capacity/En soulevant la capacité /Levantando capacidad in"Kg"
m Mass/measurement/des mesure/de medición in"m"

****** - Optional { manuelle Verlängerung
manuell extension
l'extension mécanique
extensiones manuales

***** - { zusätzlicher Lasthakenpunkt am Knickarm
additional load hook point at jib
supplémentaires point crochet à fleche
carga adicional punto de gancho en la horca

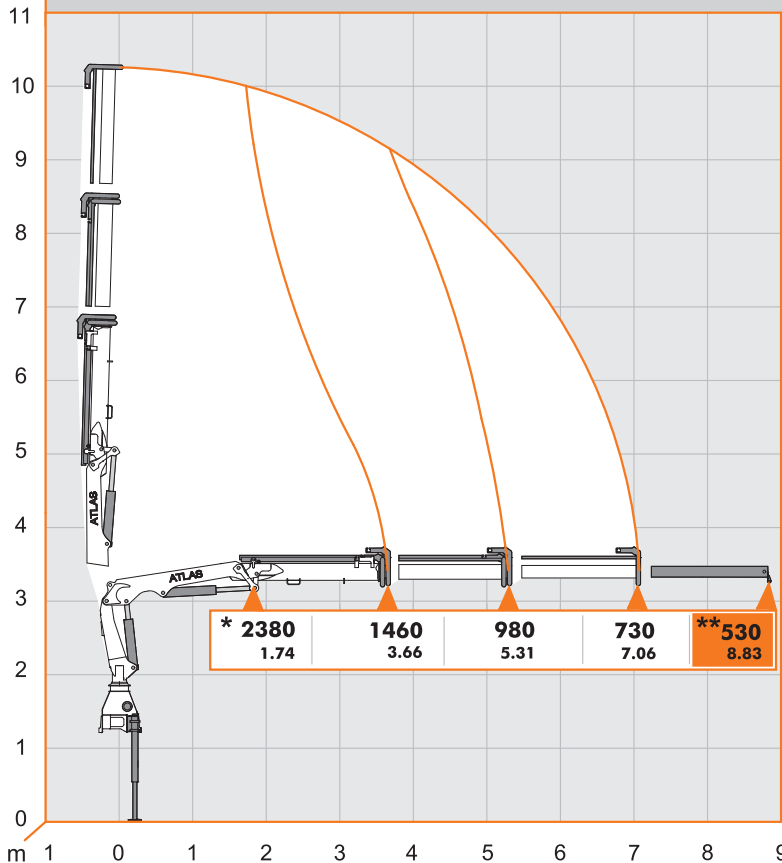

AK 57.3 A2L

Kg Traglast/lifting capacity/En soulevant la capacité /Levantando capacidad in"Kg"
m Mass/measurement/des mesure/de medición in"m"

LASTKURVEN

Load Diagram-Courbes de charges-Curvas de cargas - Diagramma di portata

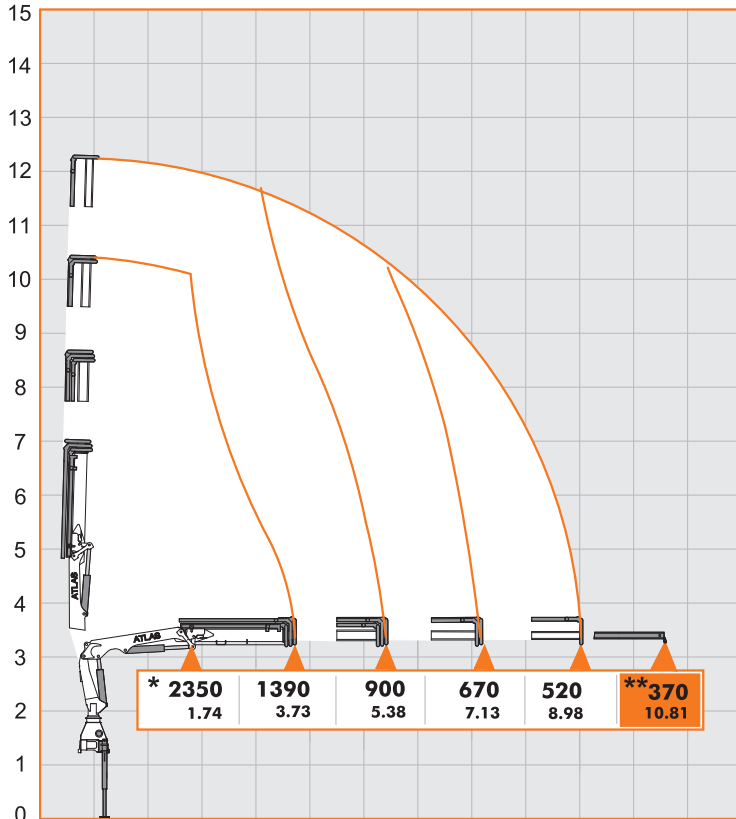

Hubarmstellung 10° / boom position 10° / Faites tonner la position à 10° / Lance posición 10°

AK 57.3 A3L

Kg Traglast/lifting capacity/En soulevant la capacité /Levantando capacidad in"Kg"

m Mass/measurement/des mesure/de medición in"m"

****** - Optional { manuelle Verlängerung
manuell extension
l'extension mécanique
extensiones manuales

***** ----- { zusätzlicher Lasthakenpunkt am Knickarm
additional load hook point at jib
supplémentaires point crochet à fleche
carga adicional punto de gancho en la horca

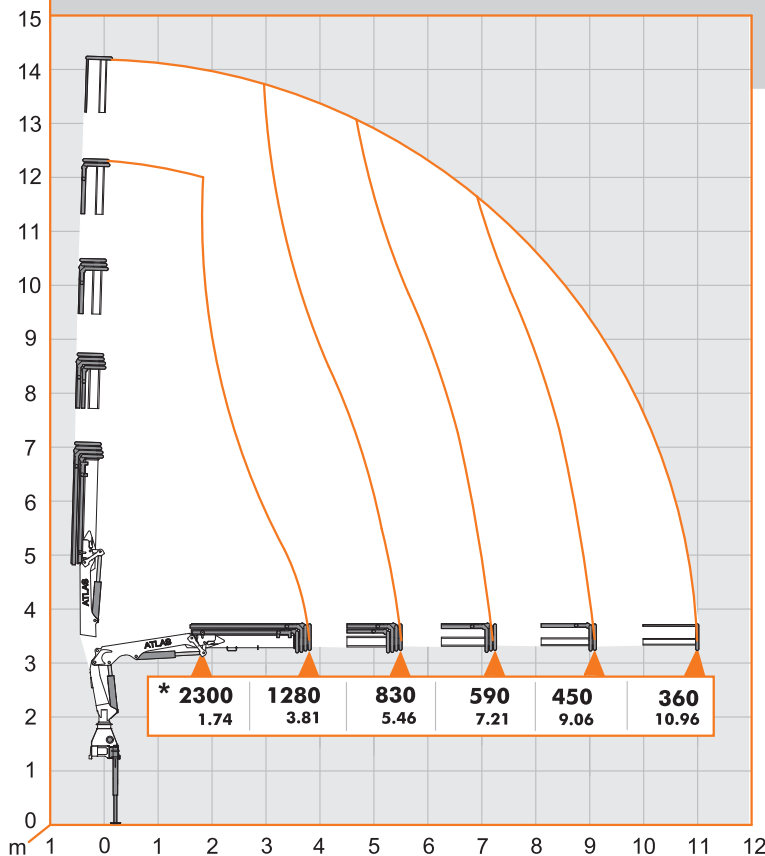

AK 57.3 A4L

Kg Traglast/lifting capacity/En soulevant la capacité /Levantando capacidad in"Kg"





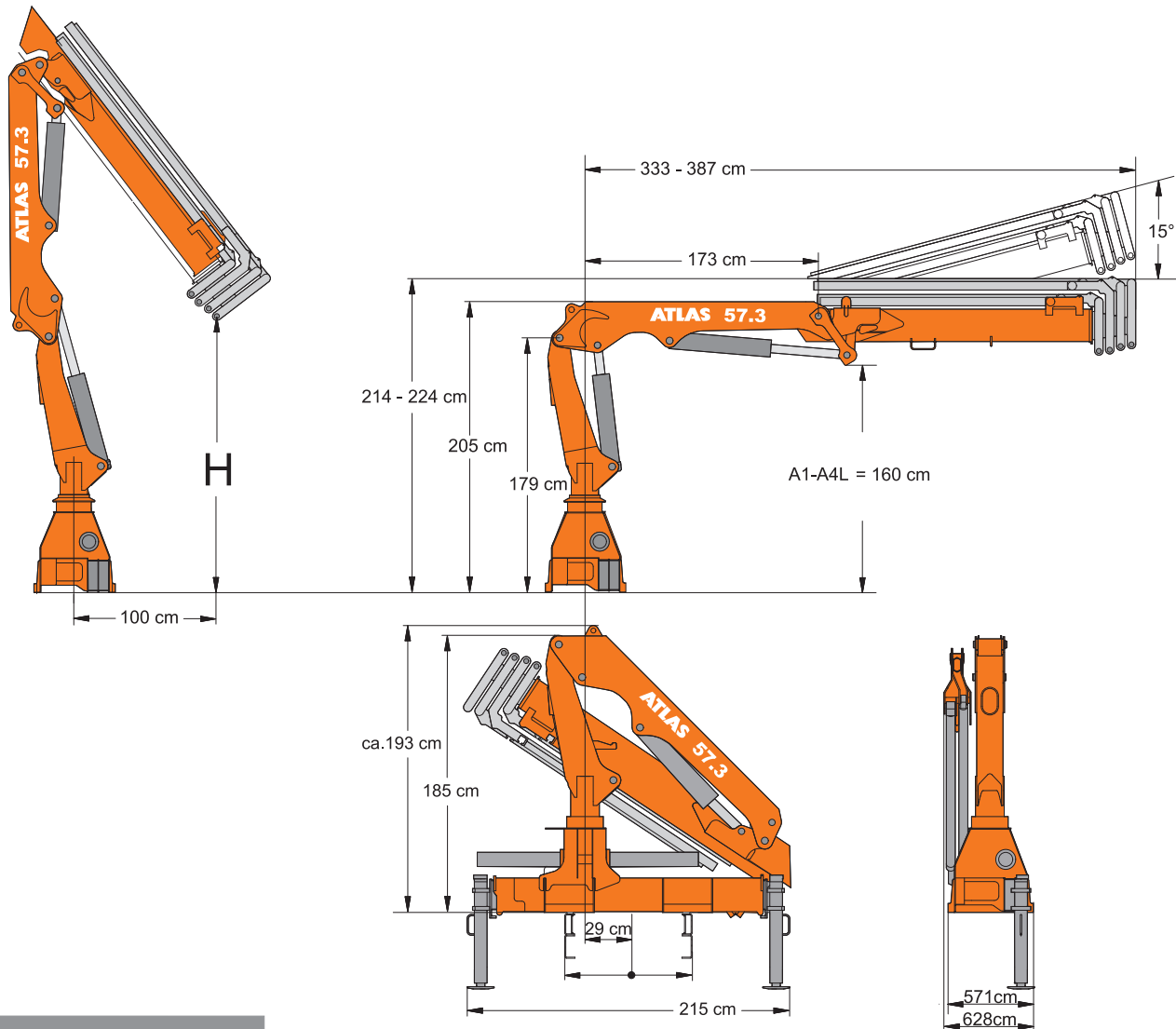

m Mass/measurement/des mesure/de medición in"m"

ABMESSUNGEN

Dimensions - Dimensions - Dimensiones

LADEKRAN AK 57.3



AK 57.3		H1/B3					
	Gewicht Weight poids Peso	H	Betriebsdruck operating pressure pression de service Presión de servicio	Ölfördermenge oil supply amount débit d'huile Caudal de aceite	Schwenkbereich swivel range plage de pivotement Alcance de giro	Schwenkmoment swivel moment couple de pivotement Par de giro momento	Hubmoment moment of leverage Momento de elevación Momento di sollevamento
							
	Kg	m	bar	l/min		kNm	mt
A 1	763	2,66	300	25	390°	10,0	5,54
A 2	829	2,54	300	25	390°	10,0	5,41
A 1L	774	2,26	300	25	390°	10,0	5,54
A 2L	844	2,16	300	25	390°	10,0	5,34
A 3L	912	2,03	300	25	390°	10,0	5,23
A 4L	974	1,93	300	25	390°	10,0	5,14

 → einfaches Grundgerät im Lasthakenbereich /
simple basic unit for loadhook work /
type de base simple avec crochet /
maquina base para trabajo con gancho

WIRTSCHAFTLICH, FLEXIBEL, STARK

Economical, flexible, strong - économique, flexible, forte - economica, flexible, fuerte

AUSSTATTUNG

Facilities - Equipements - Instalaciones



Seilwinde
Cable winch
Treur á Cábale
Cabrestante



Hubarbeitskorb
Man Basket
Panier de Travail
Hombre cesta



Z-Arm
Jib-Boom
Braz Z
Brazo en Z

Zusatzabstützträger
Additional outriggers
D`autres stabilisateurs
Adicional estabilizadores



STEUERUNG

Control - Contrôle - Control

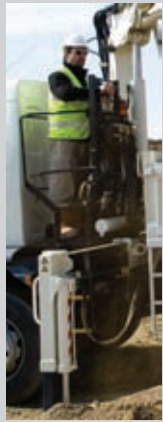

ABSTÜTZÜBERWACHUNG

Monitoring of the stabilizing support - suivi de l'appui de stabilisation
- seguimiento del apoyo estabilización

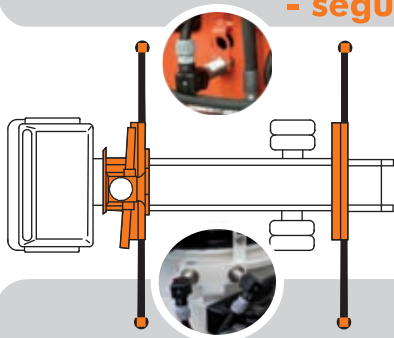

(EAW) nach EN 12999

elektr. Überwachung der Abstützweite und des Schwenkwinkels
electr. monitoring of the stabilizing support wide and the slewing range
contrôle électrique de l'écartement de stabilisatin et de l'angle de rotation
control electrico de los estabilizadores y del angulo de rotación

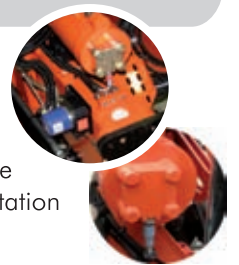

WERKZEUGE

Tools - Outils - Herramientas



Steinstapelzange
Brick Stack Grapples
Pincas á Parpaings
Pinza



Greifer
Grabber
Grappin
el garfio



Krangabel
Pallet Fork
Fourches
Paleta Tenedor



ATLAS

- AVAILABLE & COST EFFECTIVE -

ATLAS

ATLAS



sicher

save, sécurité, seguro

flexibel

flexible, flexible, flexible

innovativ

innovativ, innovante, innovadora

effizient

efficient, efficace, eficiente

kraftvoll

powerful, puissant, poderoso

Atlas Maschinen GmbH

erreichbar

available, joignable, alcanzado



Stedinger Straße 324
D-27751 Delmenhorst
Tel. +49 (0) 4221-491 - 0
Fax +49 (0) 4221-491-443
info@atlasgmbh.com

www.atlasgmbh.com

YOUR CONTACT INFORMATION